

They are rotary vane vacuum pumps with disposable lubrication, with a suction flow rate of 40 m<sup>3</sup>/h.

Characterized by a simple construction, they are robust and well-cooled. The lubrication is adjustable by using two drop oilers located at the support bearings.

In this version, there is a cartridge-type oil separator filter installed at the exhaust, which significantly reduces smoke emissions.

The lubricating oil is contained within a transparent tank; the oil level is monitored by an electromagnetic sensor. The oil is drawn into the pump through the drop oilers, then discharged into the recovery tank positioned below the pump's silencer, and is not recirculated thereafter.

The pump rotor and shaft are a single piece, supported by independent bearings mounted within the two pump end flanges. The pump and electric motor are thus two independent units, fixed to a dedicated support and connected to each other by an elastic coupling.

The BVL/G1 series pumps are supplied only with three-phase electric motors (UL-CSA certified). Upon request, the pumps can be supplied with ATEX-certified motors, with special voltages and frequencies, or without motor. The pump is cooled by a radial fan located between the motor and the pump.

On the pump discharge, there is an oil recovery tank containing a separator filter that prevents the formation of oil mists and reduces noise.

### Use and installation

The use of these pumps is essential when the fluid to be aspirated contains solvent vapors, water condensates, or any other substances that could contaminate the lubricating oil.

For the installation of OMMER vacuum pumps, it is sufficient to connect them to the vacuum circuit and set up the electrical connection to the motor.



040LGD1-LP-LE			
Frequency		50Hz	60Hz
Flow rate	m <sup>3</sup> /h	40	48
Ultimate pressure	mbar	65	
Motor performance	3~	230/400±5%	265/460±5%
	1~		
Motor power	3~	1,10	1,30
	1~		
Motor protection	IP	55	
Rotation speed	rpm	1450	1750
Motor shape		B5	
Motor size		90	
Weight	kg	55	

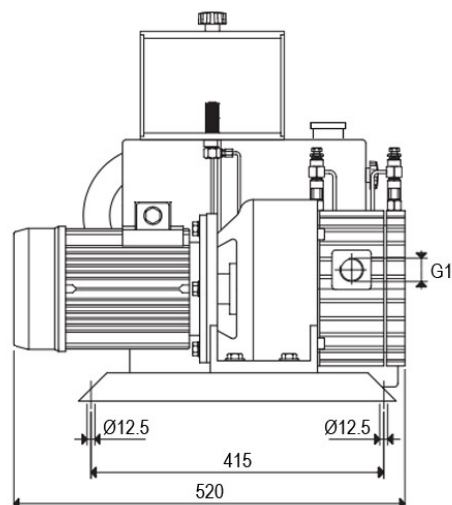
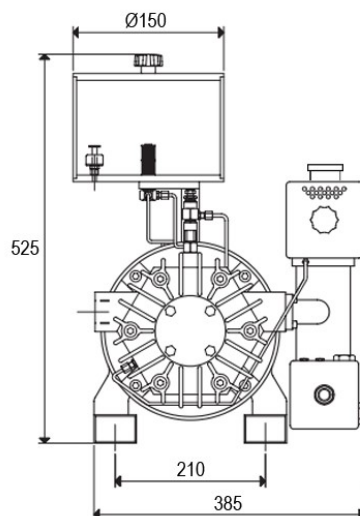

Data and dimensions are not mandatory. O.M.M.E.R. S.r.l. reserves the right to make changes and improvements at any time and without notice.

